

Catifa 46

Design by Lievore Altherr Molina, 2012

Art. 0279

Chair with polished or powdercoated aluminium swivel trestle base. Polypropylene shell with cushion upholstered in fabric, leather, faux leather or customer's own material applied to the seat surface. Steel armrests, also upholstered, are available upon request.



Dimensions *

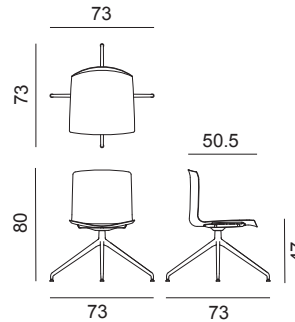

* File CAD 2D - 3D available for download at www.arper.com

Frame Base



Shell

Polypropylene



PO Polypropylene two colors
PO Polypropylene one color

Carded In



Graded In

arper

F +39 0422 791800

T +39 0422 7918

www.arper.com

kvadrat

camira



DESIGN
TEX



Gabriel



svensson

maharam

Serge Ferrari

Catifa 46

Design by Lievore Altherr Molina, 2012

Accessories:



Set of glides Art. 2015



Armrests BV



Armrests CI - only pad

SHIPMENT DETAILS

Art.0279

1 pz = 2 - kg 12,8/ m² 0,27
4 pz = 2 - kg 37,84/ m² 0,4

RESISTANCE TEST

- EN 1728:2000 - EN 15373:2007 6.15
- EN 1728:2000 - EN 15373:2007 6.2.1
- EN 1728:2000 - EN 15373:2007 6.7
- EN 1728:2000 - EN 15373:2007 6.16
- EN 1728:2000 - EN 15373:2007 6.2.2
- EN 1728:2000 - EN 15373:2007 6.8

TECHNICAL SPECIFICATIONS

Art.0279

COL requirement m² 0.48
H 140 cm. COM Meterage ml 0.59

FIRE RETARDANT TEST

Classe 1IM Cava 3 Divina MD Divina Melange 2 Divina 3 Hallingdal 65 Pro 3 Soft leather Tonus 4 Faux leather Valencia • California TB117-2013 Cava 3 Clara Canvas Divina MD Divina Melange 2 Divina 3 Soft leather Elmosoft Field Hallingdal 65 Jet Jumper 3 Pro 3 Soft leather Remix 2 Savanna Steelcut 2 Scuba Steelcut Trio 2 Steelcut Trio 3 Sunniva Sunniva 2 Tonus 4 Tempo Faux leather Valencia • BS5852 Sch. 4 Part 1 Cava 3 Divina MD Divina Melange 2 Divina 3 Soft leather Elmosoft Hallingdal 65 Pro 3 Tonus 4 Faux leather Valencia • BS5852 Sch. 5 Part 1 Cava 3 Clara Canvas Divina MD Divina Melange 2 Divina 3 Soft leather Elmosoft Hallingdal 65 Soft leather Remix 2 Savanna Steelcut 2 Steelcut Trio 2 Steelcut Trio 3 Tonus 4 Faux leather Valencia • EN 1021 - 1 Divina MD Divina Melange 2 Divina 3 Soft leather Elmosoft Field Hallingdal 65 Pro 3 Soft leather • EN 1021 - 2 Divina MD Divina Melange 2 Divina 3 Soft leather Elmosoft Field Hallingdal 65 Pro 3 Soft leather

ENVIRONMENTAL CERTIFICATIONS



arper

F +39 0422 791800

T +39 0422 7918

www.arper.com

Catifa 46

Design by Lievore Altherr Molina, 2013

Art. 0316

Chair with polished or powdercoated aluminium swivel trestle base. The white polypropylene shell (PO101) is upholstered with a removable non-washable cover in leather, faux leather, fabric or customer's own material. The chair is provided already fitted with the cover. Steel armrests, also upholstered, are available upon request.



Dimensions *

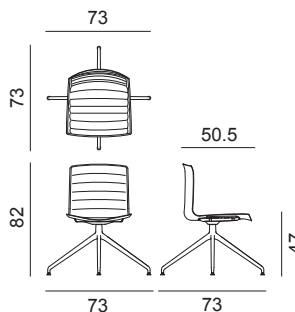

* File CAD 2D - 3D available for download at www.arper.com

Frame Base

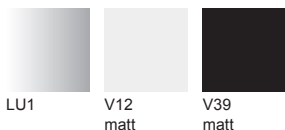

Shell

Carded In

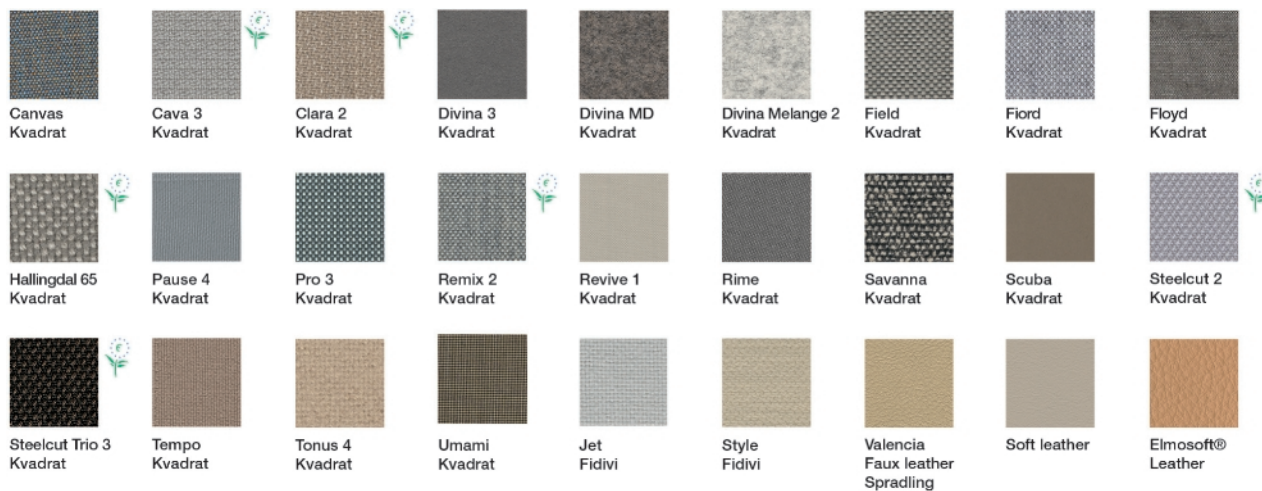

Graded In

kvadrat

camira



DESIGN
TEX



Gabriel



svensson

maharam

Serge Ferrari

Catifa 46

Design by Lievore Altherr Molina, 2013

Accessories:



Set of glides Art. 2015



Armrests BV



Armrests CI - only pad

SHIPMENT DETAILS

Art.0316

1 pz = 2 - kg 11,4/ m² 0,27
4 pz = 2 - kg 36,4/ m² 0,39

RESISTANCE TEST

- EN 1728:2000 - EN 15373:2007 6.15
- EN 1728:2000 - EN 15373:2007 6.2.1
- EN 1728:2000 - EN 15373:2007 6.7
- EN 1728:2000 - EN 15373:2007 6.16
- EN 1728:2000 - EN 15373:2007 6.2.2
- EN 1728:2000 - EN 15373:2007 6.8

TECHNICAL SPECIFICATIONS

Art.0316

COL requirement m² 1,98
H 140 cm. COM Meterage ml 1,08
The cover stitching comes in the same color as the upholstery. Stitching on cover 1 and 3 comes in white or black, to customer's choice.
Surcharge for armrest CI upholstered

FIRE RETARDANT TEST

Classe 1M Cava 3 Divina MD Divina Melange 2 Divina 3 Hallingdal 65 Pro 3 Soft leather Tonus 4 Faux leather Valencia • California TB117-2013 Cava 3 Clara Canvas Divina MD Divina Melange 2 Divina 3 Soft leather Elmosoft Field Hallingdal 65 Jet Jumper 3 Pro 3 Soft leather Remix 2 Savanna Steelcut 2 Scuba Steelcut Trio 2 Steelcut Trio 3 Sunniva Sunniva 2 Tonus 4 Tempo Faux leather Valencia • BS5852 Sch. 4 Part 1 Cava 3 Divina MD Divina Melange 2 Divina 3 Soft leather Elmosoft Hallingdal 65 Pro 3 Tonus 4 Faux leather Valencia • BS5852 Sch. 5 Part 1 Cava 3 Clara Canvas Divina MD Divina Melange 2 Divina 3 Soft leather Elmosoft Hallingdal 65 Soft leather Remix 2 Savanna Steelcut 2 Steelcut Trio 2 Steelcut Trio 3 Tonus 4 Faux leather Valencia • EN 1021 - 1 Divina MD Divina Melange 2 Divina 3 Soft leather Elmosoft Field Hallingdal 65 Pro 3 Soft leather • EN 1021 - 2 Divina MD Divina Melange 2 Divina 3 Soft leather Elmosoft Field Hallingdal 65 Pro 3 Soft leather

ENVIRONMENTAL CERTIFICATIONS



arper

F +39 0422 791800

T +39 0422 7918

www.arper.com

Catifa 46

Design by Lievore Altherr Molina, 2014

Art. 0332

Chair with polished or powdercoated aluminium swivel trestle base. Wood shell with front upholstery in leather, faux leather, fabric or customer's own material. Steel armrests, also upholstered, are available upon request.



Dimensions *

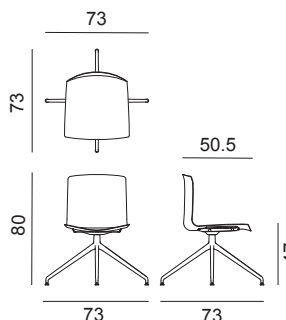

* File CAD 2D - 3D available for download at www.arper.com

Frame Base



Shell

Wood

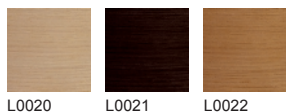

Carded In

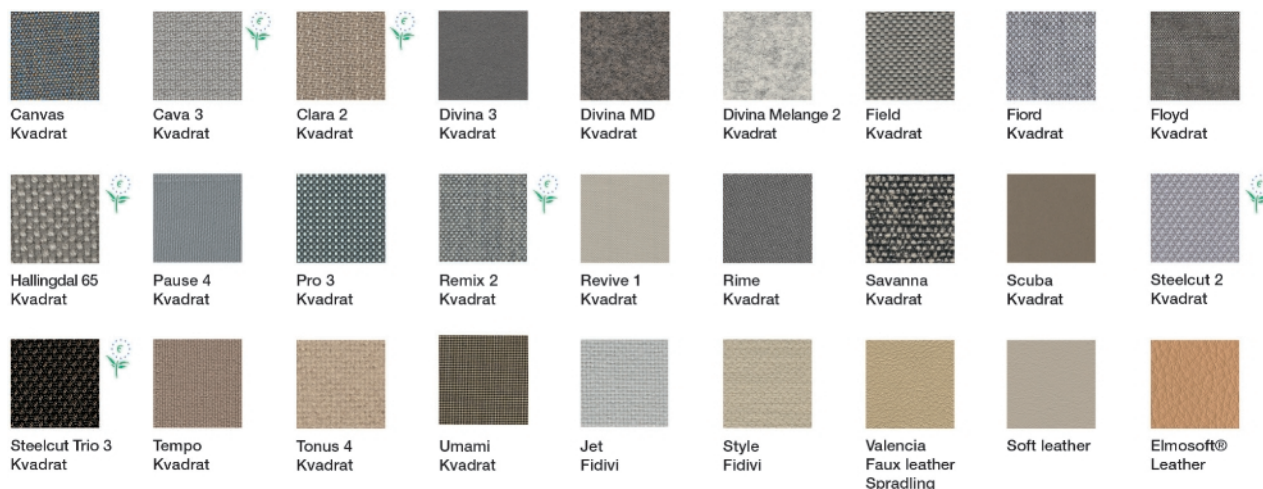

Graded In

kvadrat

camira



DESIGN
TEX



Gabriel



svensson

maharam

Serge Ferrari

Catifa 46

Design by Lievore Altherr Molina, 2014

Accessories:



Set of glides Art. 2015



Armrests BV



Armrests CI - only pad

SHIPMENT DETAILS

Art.0332

1 pz = 2  - kg 12,8/ m³ 0,27

4 pz = 2  - kg 37,84/ m³ 0,4

RESISTANCE TEST

ENVIRONMENTAL CERTIFICATIONS

TECHNICAL SPECIFICATIONS

Art.0332

COL requirement m² 0.84

H 140 cm. COM Meterage ml 0.65

FIRE RETARDANT TEST

BS5852 Sch. 4 Part 1 Faux leather Valencia

arper

F +39 0422 791800

T +39 0422 7918

www.arper.com

Catifa 46

Design by Lievore Altherr Molina, 2004

Art. 0368

Chair with polished or powdercoated aluminium swivel trestle base. The shell is available in single-colour polypropylene, bi-colour polypropylene or upholstered in hard leather grade 1 (CT) or hard leather grade 2 (CU). Polypropylene and steel armrests, are available upon request.



Dimensions *

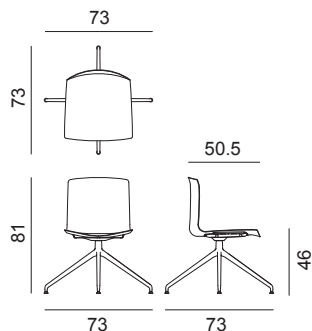

* File CAD 2D - 3D available for download at www.arper.com

Frame Base

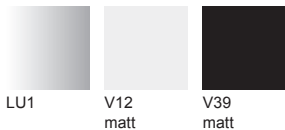

Shell

Polypropylene

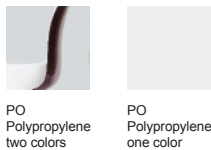

Hard leather Grade 1 and Grade 2

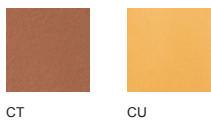

arper

F +39 0422 791800

T +39 0422 7918

www.arper.com

Catifa 46

Design by Lievore Altherr Molina, 2004

Accessories:



Cushion Art. 0261



Set of glides Art. 2015



Armrests BV



Armrests CV - pad (only for PO)

SHIPMENT DETAILS

Art.0368

1 pz = 2  - kg 10,1/ m² 0,25

4 pz = 2  - kg 30,4/ m² 0,34

RESISTANCE TEST

- EN 1728:2000 - EN 15373:2007 6.15
- EN 1728:2000 - EN 15373:2007 6.2.1
- EN 1728:2000 - EN 15373:2007 6.7
- TUV GS (EN16139)
- EN 1728:2000 - EN 15373:2007 6.16
- EN 1728:2000 - EN 15373:2007 6.2.2
- EN 1728:2000 - EN 15373:2007 6.8

ENVIRONMENTAL CERTIFICATIONS



TECHNICAL SPECIFICATIONS

FIRE RETARDANT TEST

BS5852/90 Sez.5 cigarette match polypropylene • Classe 1
polypropylene • EN 1021 -1/2 polypropylene • M2 polypropylene •
California TB133 polypropylene • BS5852 Sch. 5 Part 1 CT CU

arper

F +39 0422 791800

T +39 0422 7918

www.arper.com

Catifa 46

Design by Lievore Altherr Molina, 2004

Art. 0370

Chair with polished or powdercoated aluminium swivel trestle base. Polypropylene shell with front upholstery in leather, faux leather, fabric or customer's own material. Steel armrests, also upholstered, are available upon request.



Dimensions *

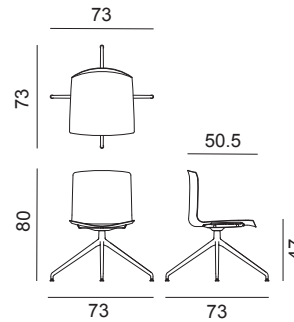

* File CAD 2D - 3D available for download at www.arper.com

Frame Base



Shell

Polypropylene



PO
Polypropylene
one color

Carded In



Graded In

kvadrat

camira



DESIGN
TEX



Gabriel



svensson

maharam

Serge Ferrari

Catifa 46

Design by Lievore Altherr Molina, 2004

Accessories:



Set of glides Art. 2015



Armrests BV



Armrests CI - only pad

SHIPMENT DETAILS

Art.0370

1 pz = 2 - kg 12,8/ m² 0,27
4 pz = 2 - kg 37,84/ m² 0,4

RESISTANCE TEST

- EN 1728:2000 - EN 15373:2007 6.15
- EN 1728:2000 - EN 15373:2007 6.2.1
- EN 1728:2000 - EN 15373:2007 6.7
- TÜV GS (EN16139)
- EN 1728:2000 - EN 15373:2007 6.16
- EN 1728:2000 - EN 15373:2007 6.2.2
- EN 1728:2000 - EN 15373:2007 6.8

TECHNICAL SPECIFICATIONS

Art.0370

COL requirement m² 0.84
H 140 cm. COM Meterage ml 0.65

FIRE RETARDANT TEST

Classe 1IM Cava 3 Divina MD Divina Melange 2 Divina 3 Hallingdal 65 Pro 3 Soft leather Tonus 4 Faux leather Valencia • California TB117-2013 Cava 3 Clara Canvas Divina MD Divina Melange 2 Divina 3 Soft leather Elmosoft Field Hallingdal 65 Jet Jumper 3 Pro 3 Soft leather Remix 2 Savanna Steelcut 2 Scuba Steelcut Trio 2 Steelcut Trio 3 Sunniva Sunniva 2 Tonus 4 Tempo Faux leather Valencia • BS5852 Sch. 4 Part 1 Cava 3 Divina MD Divina Melange 2 Divina 3 Soft leather Elmosoft Hallingdal 65 Pro 3 Tonus 4 Faux leather Valencia • BS5852 Sch. 5 Part 1 Cava 3 Clara Canvas Divina MD Divina Melange 2 Divina 3 Soft leather Elmosoft Hallingdal 65 Soft leather Remix 2 Savanna Steelcut 2 Steelcut Trio 2 Steelcut Trio 3 Tonus 4 Faux leather Valencia • EN 1021 - 1 Divina MD Divina Melange 2 Divina 3 Soft leather Elmosoft Field Hallingdal 65 Pro 3 Soft leather • EN 1021 - 2 Divina MD Divina Melange 2 Divina 3 Soft leather Elmosoft Field Hallingdal 65 Pro 3 Soft leather

ENVIRONMENTAL CERTIFICATIONS



arper

F +39 0422 791800

T +39 0422 7918

www.arper.com

Catifa 46

Design by Lievore Altherr Molina, 2004

Art. 0375

Chair with polished or powdercoated aluminium swivel trestle base. The shell is upholstered in leather, faux leather, fabric or customer's own material. Steel armrests, also upholstered, are available upon request.



Dimensions *

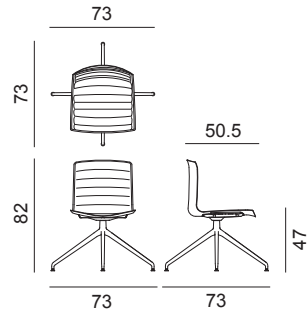

* File CAD 2D - 3D available for download at www.arper.com

Frame Base

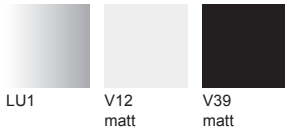

Shell

Carded In

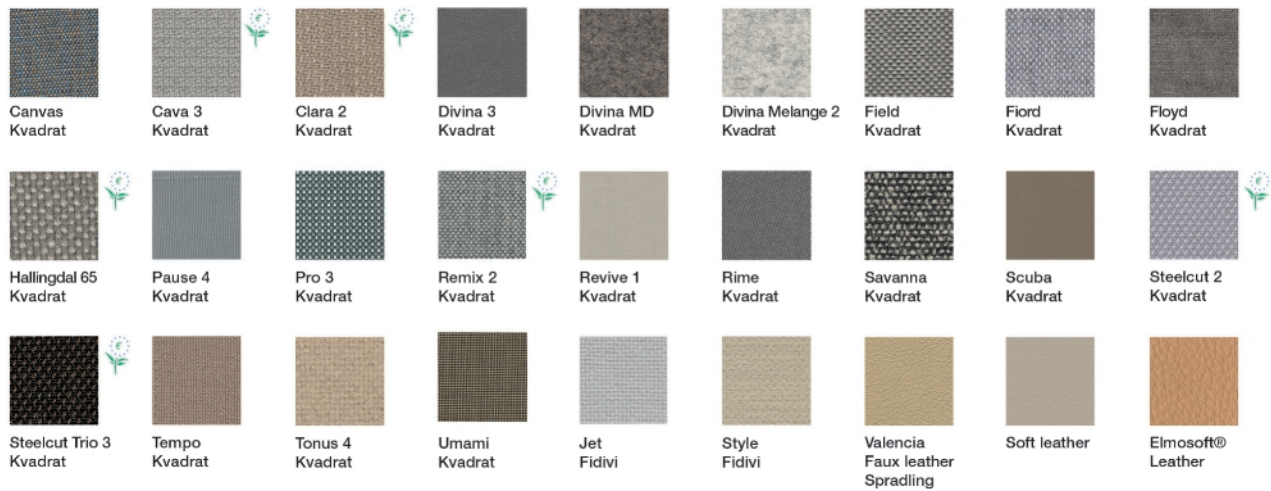

Graded In

kvadrat

camira



DESIGN
TEX



Gabriel



svensson

maharam

Serge Ferrari

Catifa 46

Design by Lievore Altherr Molina, 2004

Accessories:



Set of glides Art. 2015



Armrests BV



Armrests CI - only pad

SHIPMENT DETAILS

Art.0375

1 pz = 2 - kg 11,4/ m² 0,27
4 pz = 2 - kg 36,4/ m² 0,39

TECHNICAL SPECIFICATIONS

Art.0375

COL requirement m² 1.67
H 140 cm. COM Meterage ml 1.1
Line stitching

RESISTANCE TEST

- EN 1728:2000 - EN 15373:2007 6.15
- EN 1728:2000 - EN 15373:2007 6.2.1
- EN 1728:2000 - EN 15373:2007 6.7
- TUV GS (EN16139)
- EN 1728:2000 - EN 15373:2007 6.16
- EN 1728:2000 - EN 15373:2007 6.2.2
- EN 1728:2000 - EN 15373:2007 6.8

FIRE RETARDANT TEST

Classe 1IM Cava 3 Divina MD Divina Melange 2 Divina 3 Hallingdal 65 Pro 3 Soft leather Tonus 4 Faux leather Valencia • California TB117-2013 Cava 3 Clara Canvas Divina MD Divina Melange 2 Divina 3 Soft leather Elmosoft Field Hallingdal 65 Jet Jumper 3 Pro 3 Soft leather Remix 2 Savanna Steelcut 2 Scuba Steelcut Trio 2 Steelcut Trio 3 Sunniva Sunniva 2 Tonus 4 Tempo Faux leather Valencia • BS5852 Sch. 4 Part 1 Cava 3 Divina MD Divina Melange 2 Divina 3 Soft leather Elmosoft Hallingdal 65 Pro 3 Tonus 4 Faux leather Valencia • BS5852 Sch. 5 Part 1 Cava 3 Clara Canvas Divina MD Divina Melange 2 Divina 3 Soft leather Elmosoft Hallingdal 65 Soft leather Remix 2 Savanna Steelcut 2 Steelcut Trio 2 Steelcut Trio 3 Tonus 4 Faux leather Valencia • EN 1021 - 1 Divina MD Divina Melange 2 Divina 3 Soft leather Elmosoft Field Hallingdal 65 Pro 3 Soft leather • EN 1021 - 2 Divina MD Divina Melange 2 Divina 3 Soft leather Elmosoft Field Hallingdal 65 Pro 3 Soft leather

ENVIRONMENTAL CERTIFICATIONS



arper

F +39 0422 791800

T +39 0422 7918

www.arper.com

Catifa 46

Design by Lievore Altherr Molina, 2004

Art. 0377

Chair with polished or powdercoated aluminium swivel trestle base. The wood shell is available in three colours (natural oak, bleached oak or wengé). Steel armrests are available upon request.



Dimensions *

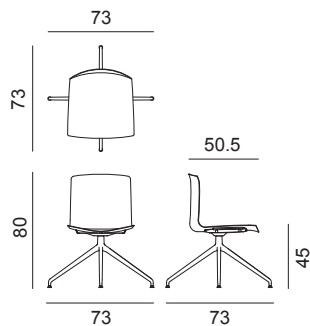

* File CAD 2D - 3D available for download at www.arper.com

Frame Base

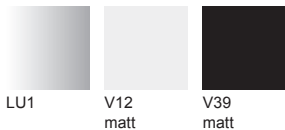

Shell

Wood

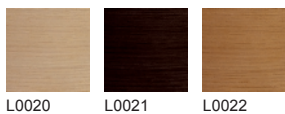

arper

F +39 0422 791800

T +39 0422 7918

www.arper.com

Catifa 46

Design by Lievore Altherr Molina, 2004

Accessories:



Cushion Art. 0261



Set of glides Art. 2015



Armrests BV

SHIPMENT DETAILS

Art.0377

1 pz = 2  - kg 9,58/ m² 0,24

4 pz = 2  - kg 28,3/ m² 0,35

RESISTANCE TEST

- TUV GS (EN16139)

ENVIRONMENTAL CERTIFICATIONS



TECHNICAL SPECIFICATIONS

FIRE RETARDANT TEST

BS5852/90 Sez.5 cigarette match LG • Classe 1 LG

arper

F +39 0422 791800

T +39 0422 7918

www.arper.com